



Select Metal French Return Elbows

Measurements and Installation for Select Metal Brass and Iron Works

3/4" French Return Elbows - Brass

	3/4" 120-4063	3/4" Ext. 120-4066
Return	3 1/2"	5 3/4"
Projection	4 1/8"	6 1/4"
Length	5"	5"

1 3/16" French Return Elbows - Brass

	1 3/16" 130-4063	1 3/16" Ext. 130-4066
Return	3 3/4"	6 1/2"
Projection	4 1/2"	7 1/4"
Length	5"	5"

French Return Elbows - Iron Works

	3/4" 120-4063	1 3/16" 130-4063
Return	3 1/4"	3 1/2"
Projection	4"	4 3/8"
Length	5"	5"

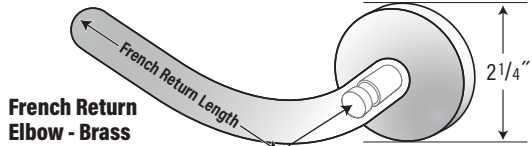

French Return Elbow - Brass

French Return Length = 5"
Measured from end to center of bracket knob

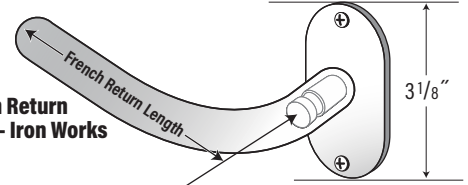
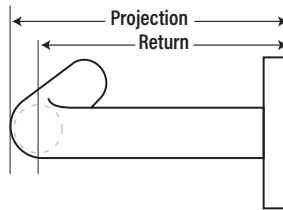

French Return Elbow - Iron Works

French Return Length = 5"
Measured from end to center of bracket knob

French Return Elbow Measuring and Installation

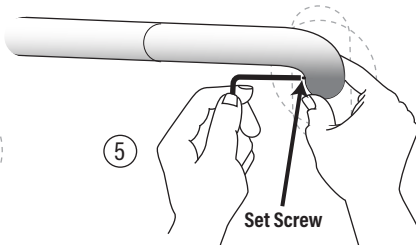
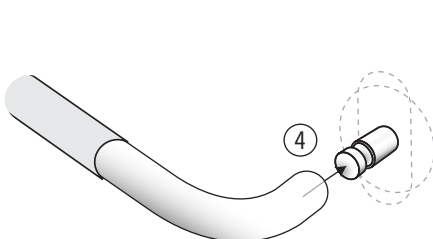
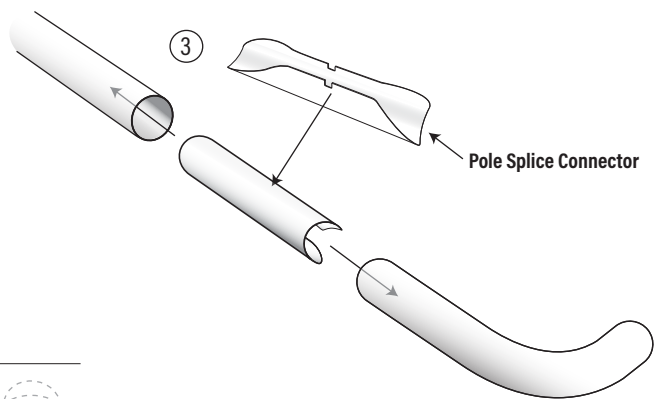
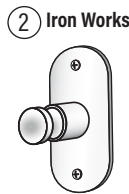
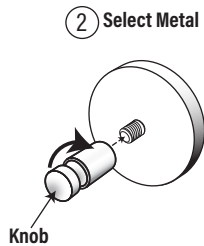
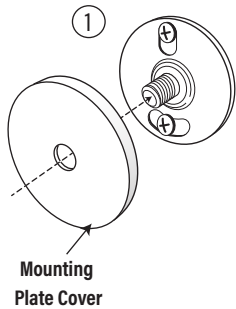
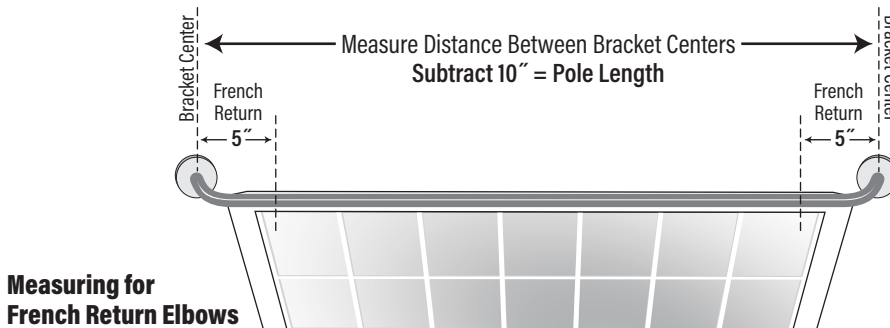

1. Secure Mounting Plate to wall.
2. **Select Metal** - Screw Knob Onto Mounting Plate
Iron Works - Mounting Plate Includes Knob
3. Insert Connector Between Pole and Elbow
4. Slide Elbow Onto Knob
5. Secure French Return with Set Screw